

**KREEPY
KRAULY**

PROUDLY AUSTRALIAN
DESIGNED AND MADE



VTX-3

OWNER'S MANUAL

Congratulations

Your new Kreepy Krauly VTX-3 is designed to give you years of reliable performance. As soon as you complete the final assembly steps, it's ready to use. Don't worry, it doesn't take long and this guide will walk you through assembly and installation step-by-step.

This booklet should answer all your questions. However if you need a little extra help, feel free to call our Customer Service Department, Mon-Fri 9am-5pm in your local area, or go to the website for up-to-date information.

1800 777 255

www.kreepykrauly.com.au

Contents

- 2 *Components checklist*
- 4 *Assembling your VTX-3*
- 6 *Installing the VTX-3 in your pool*
- 11 *Fine-tuning your VTX-3*
- 12 *Authorised Kreepy Krauly Accessories*
- 13 *Troubleshooting*
- 18 *Looking after your VTX-3*
- 19 *What should I expect from my VTX-3?*
- 20 *Warranty information*

Components checklist

You will find all the pictured components inside this box.

Male-male hose x1

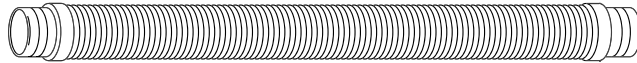

Male-female hose x9

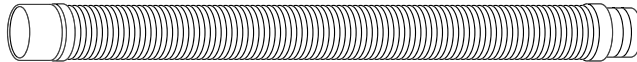

Hose weights x2



Hose protector sleeve



Smart-Skim

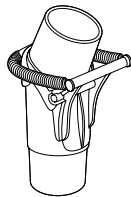

Smart-Skim adaptors



used with most vacuum plates



used with Polyplastics 190 & 210 standard



used with Polyplastics SK1000 (rectangular)

Floataction assembly

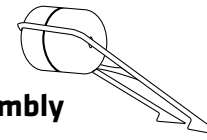

Deflector wheel

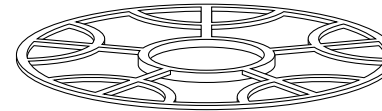

VTX-3 cleaner unit

Main body

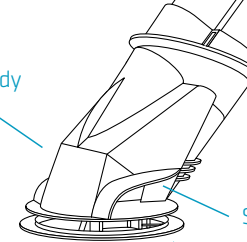

Side leaf scoop

Serial number

Swivel head assembly

Weighted bumper strap

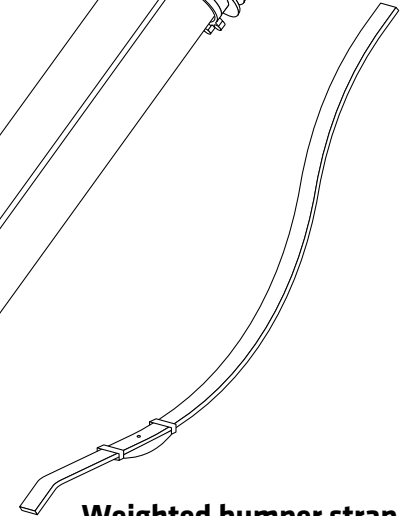

Standard seal

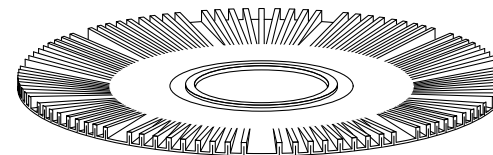

Sole



Assembling your VTX-3

STEP 1 Attach the Seal

Slide the seal onto the groove at the bottom of the main assembly body so it's able to rotate freely.

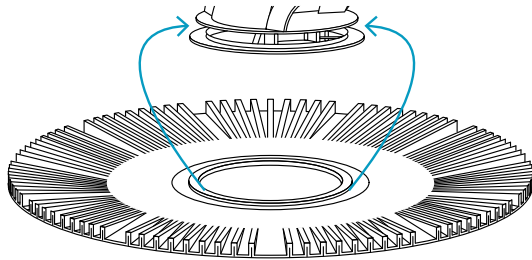

TIP: If the seal does not sit in this groove it will affect the cleaners scrubbing and climbing.

STEP 2 Attach the Slip Rings and Sole

Fit the slip rings and sole to the base of the main body. Ensure the sole is fitted all the way around.

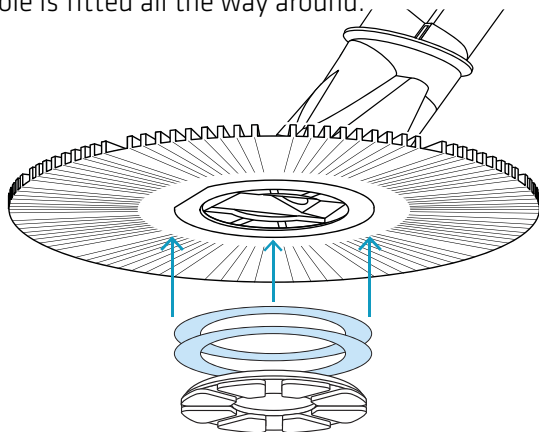

STEP 3

OPTIONAL Only install in above ground pools, or as recommended by your pool professional.

Install the Deflector

Slide the deflector (with locking clips facing down) over the tubes and click it onto the housing above the main body.

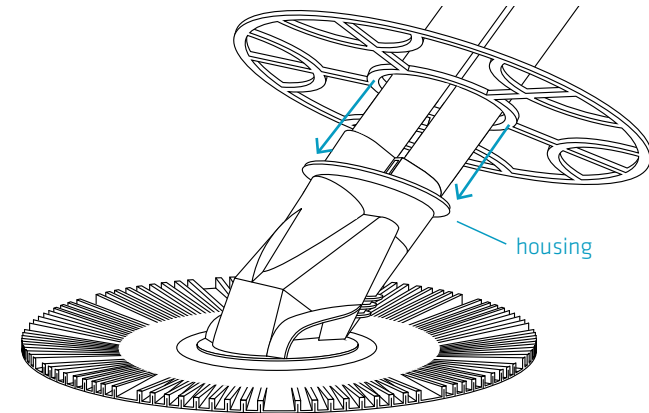

STEP 4

Install the Floatation Assembly

Press the float arms into the grey housing until they click.

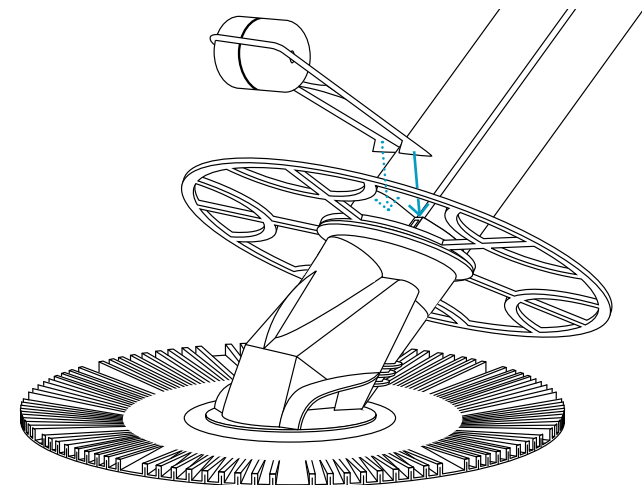

STEP 5

Attach the Bumper Strap

Insert the bent end of the bumper strap through the deflector (which will prevent it from spinning) and into the back of the main body (near the bottom of the cleaner). Insert the other end into the swivel head assembly.

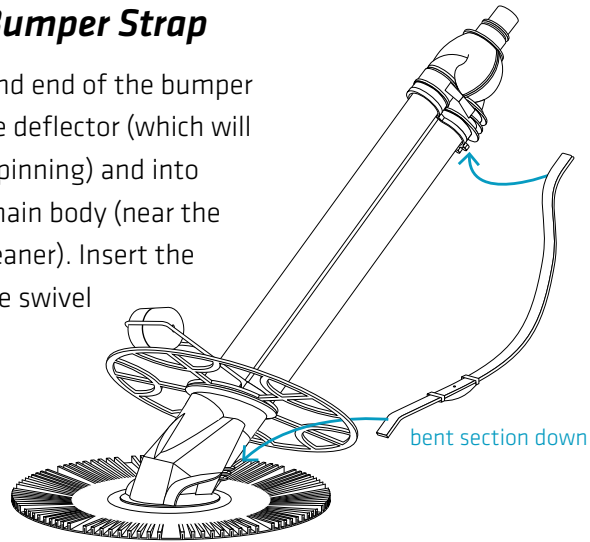

Installing the VTX-3 in your pool

STEP 1

Prepare your pool

If your pool is clean, balanced and algae-free, you're ready to get started.

- First, clean the skimmer and pump basket.
- Check the water level.
- Brush down the sides of your pool.
- Next, make sure the return jets are facing downwards.
- Then, backwash or clean your cartridge filter.
- Now turn off the pump.**

STEP 2

Fit the Smart Skim Valve

Insert the Smart-Skim into an adaptor fitting, then attach to your vacuum plate.

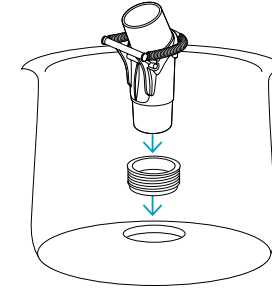

used with most vacuum plates



used with Polyplastics 190 & 210 standard



used with Polyplastics SK1000 (rectangular)

TIP: Depending on your vacuum plate, you may have to **use a different skim adaptor** – we've included three to choose from. You know you're using the right **one** when there's a tight fit. See our website for help.

TIP: For Poolrite Vacuum Plates please ensure the first thread adaptor (with the taper top facing up) is screwed in from the underside of the plate to sit flush with the bottom. This will ensure the valve can operate efficiently.

NOTE: To remove, **ensure pump is off** and grasp from the base of the Smart-Skim, pulling up. (Note: Not from the hose or spring).

OPTIONAL UPGRADE: For superior vacuum control and surface skimming, why not try our AutoSkim upgrade with custom vacuum plate? (see page 12).

STEP 3 **Build the Ultra Flex Hose**

Start with the male-male hose and twist on a female length. Keep going until the hose is long enough to reach from your skimmer box to the far corner of your pool plus around 1.5 metres extra – this will optimise the coverage of your VTX-3.

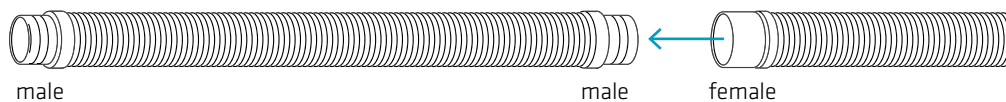

TIP: Wetting the hose ends in your pool will make them easier to connect to each other.

NOTE: If your cleaner tends to favour a corner in the pool, remove one length.

STEP 4 **Attach the Hose Weight**

Pull apart the second and third hose sections, slide on the weight then reconnect the hose. The weight should sit approximately 2m from the end of the hose that connects to the VTX-3.

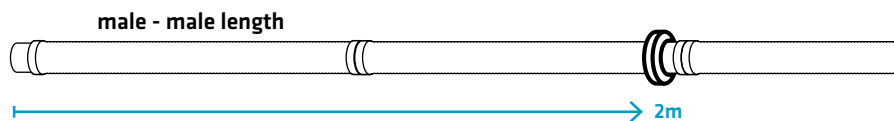

TIP: For pools deeper than 2m, use an additional weight at 4m – pull apart the fourth and fifth hose sections, slide on the weight then reconnect.

STEP 5 **Submerge the Hose**

Submerge the assembled hose in your pool to expel all the air by pushing downwards and feeding the hose into the pool.

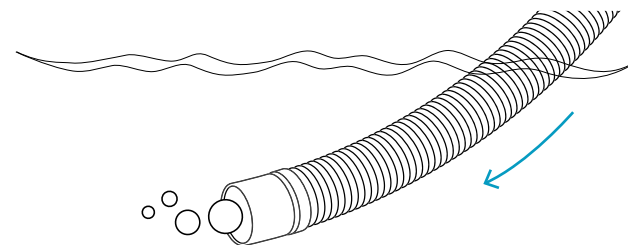

STEP 6 **Connect the Hose to the VTX-3**

Submerge the VTX-3 in your pool to expel all air (rotate to help remove trapped air). Now connect the weighted end of the submerged hose to the swivel head assembly of the VTX-3.

NOTE: Please do not use any other brand of pool cleaner hose with your VTX-3 or performance and coverage will be impaired.

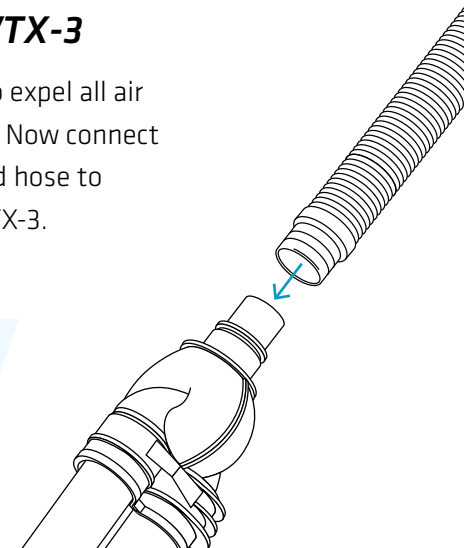

STEP 7

Connect Hose to the Skim Valve

Slide the protector sleeve onto the end of the hose. Connect the hose to the Smart-Skim valve (or Auto Skim valve if using the upgrade.) There are two options for the path of the hose:

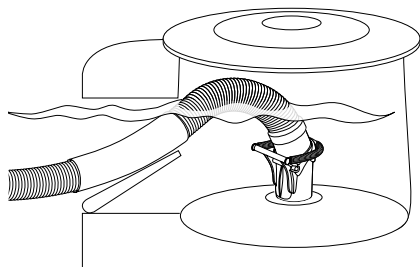

Option 1:

Hose through the skimmer box door.

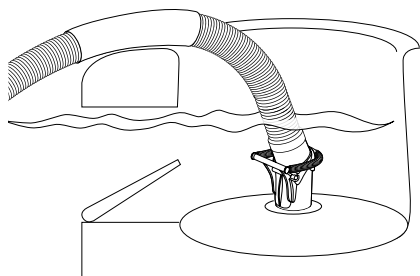

Option 2 (improves surface skimming):

Hose through the top of the skimmer box, cover removed.

Position the protector sleeve to protect the hose from wear where it is in contact with the pool edge or skimmer box door.

NOTE: Ensure your pump is off when doing this.

TIP: For option 2, cover end of hose with palm of hand when lifting into skimmer box so air is not present in the hose.

STEP 8

Turn on the pump

Your VTX-3 should now be up and running. You should hear a gentle ticking – that's your cue to relax while the VTX-3 gets to work cleaning your pool.

Fine-tuning your VTX-3

Depending on your pool's shape and surface, you may need to make some small tweaks to optimise the performance of your VTX-3.

How to achieve the right incline

VTX-3 works best when the main body sits at a 45° incline to the pool surface.

If your cleaner is lifting (greater than 45°), move the hose weight towards the cleaner. To test if it is sitting correctly turn off the pump, tow the VTX-3 into 1.2 metres of water and observe how it sits when it settles to the bottom. Adjust the hose weight further if needed.

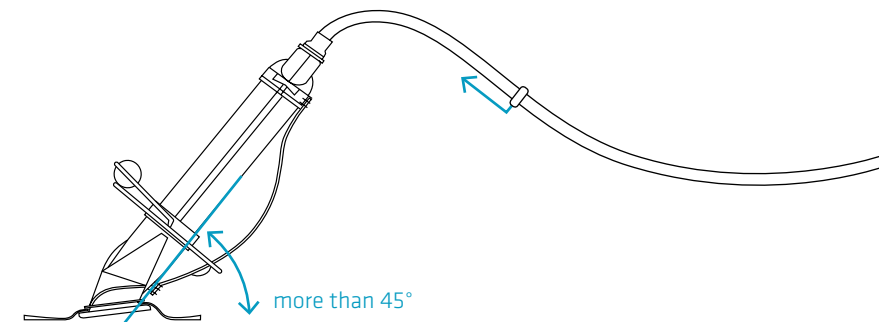

If your cleaner is sitting lower than 45° move the hose weight away from the cleaner. If it still won't sit correctly, call your pool shop or our Customer Service Centre for advice.

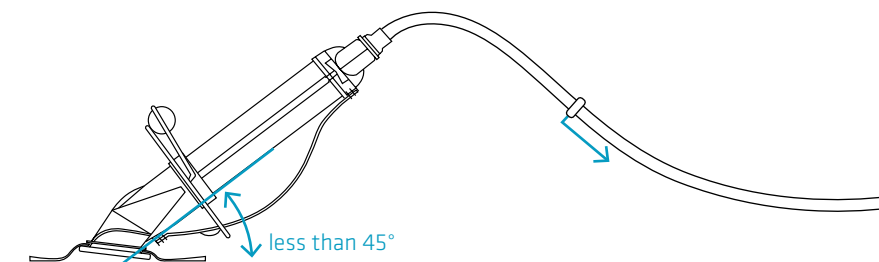

Authorised Kreepy Krauly Accessories

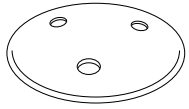

Main Drain Cover

Place over main drain grille to ensure the VTX-3 can move smoothly. (No screws required.)

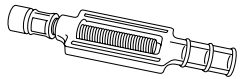

Vacuum Plate Clamp

Holds down the vacuum plate when the pool pump is off.

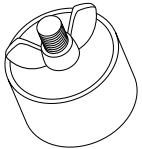

Expanding Plug

Used to block off selected skimmer box pool drain inlets.

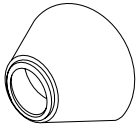

Hose Thruster

For use with the hose to steer away from problem steps and corners. (To be positioned with the opening facing the cleaner). Ask your local pool professional for setup advice for your pool.

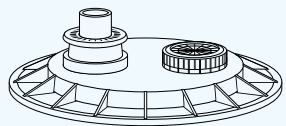

Auto Skim Upgrade

Provides premium surface skimming and vacuum regulation. The combined Vacuum Plate, Auto Skim Valve and Anti-Vortex Disc replaces the Smart-Skim and your existing vacuum plate. Your pool shop can assist you in selecting the correct replacement for your pool.

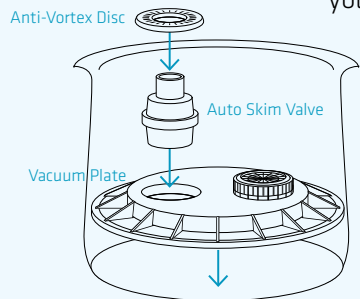

To assemble, place the Auto Skim Valve into the opening in the new Vacuum Plate and attach your hose. If you notice a slurping sound, attach the Anti-Vortex Disc over the valve inlet. Place the entire unit in the skimmer box.

Troubleshooting

VTX-3 pulsates rapidly but doesn't move, or travels very slowly:

- Check that the sole is fitted correctly.
- If the sole tread is worn away, replace it with a new sole.
- Check that the Vacuum Plate and Smart-Skim (see page 7) or Auto Skim valve are fitted correctly.
- Check the markings on the seal to make sure it hasn't been installed upside down.
- Check the Smart-Skim or Auto Skim valve isn't jammed. If it is, remove the valve from the vacuum plate, submerge the valve in water – opening and closing until it moves freely.
- Check Smart-Skim spring is correctly attached.
- Check for a blockage in the main body of your VTX-3 (see page 17).

VTX-3 travels too slowly, or doesn't pulsate:

- Check if the filter is blocked. Backwash or clean it thoroughly if required.
- Check if the flow valve at the bottom of your VTX-3 is blocked, clean out the valve (see page 19).
- Check if the pump or skimmer box strainer basket is full or blocked, clean them out.
- Check if the main drain valve is open, shut it off, or fit an optional expanding plug.
- Check for damage to the main body.

Low vacuum or slow, faltering hammering sound:

- Check large debris isn't blocking your VTX-3 or hose (see page 17).
- Check the Smart-Skim or Auto Skim valve and vacuum plate is sitting correctly in the skimmer box. You may need a different adapter for the Smart-Skim.
- Backwash filter.
- If you have more than one skimmer box, you'll need to block off water flow from the box not connected to the VTX-3.
- If the inlet from the main drain is leaking, install an expanding plug.
- Your pool pump and filter system may be too small to effectively run your VTX-3. Ask your pool pro to advise.
- Check for leaks or small holes in the main body.
- Check flow valve for damage.
- Check if the hose is damaged and replace damaged section with a new length of sectional hose. Some damage can be visually inspected

or a hissing sound can be heard coming from the hose when raised out of the water when the pump is on.

VTX-3 stays at one end of the pool:

- Check that the hose is long enough to reach the far corner of the pool. If it isn't, add extra sections.
- Check that the hose isn't kinked or coiled (see page 16).
- Check that the pool outlets aren't pushing the VTX-3 off course. Adjust downwards if necessary or use an eyeball diverter.
- Do you have enough pool weights on the hose? Additional weights may improve directional stability.

VTX-3 only travels around the water line:

- Check the hose is not coiled. If it is coiled, try to straighten the hose out (see page 16).

VTX-3 travels around the water line in only one direction:

- Check that the main body and swivel head are not out of alignment. Adjust accordingly.

The VTX-3 only climbs part way up the wall:

- Check the sole isn't worn and needs replacing.

VTX-3 becomes stuck on the main drain:

- Fit a main drain cover over the grille (see page 12).

VTX-3 keeps wedging itself on the steps:

- Shorten the pool hose slightly so the VTX-3 can't reach the steps and clean the missed area manually.
- Check seal and sole for damage.
- Fit a hose thruster (see page 12) with the wider diameter facing the cleaner at approximately 2m. Consult your pool professional or call our Customer Service Centre for advice.

VTX-3 doesn't sit at 45° and has difficulties attaching to the pool floor:

- Adjust hose weights closer to or further away from the machine until the seal is flat on the pool floor.
- Make sure the bumper strap is fitted.
- Check for damage to the machine and missing floats.

You notice bubbles at return to pool outlets:

- Check if the hose is damaged by lifting it near the surface and listening for a hissing sound. Replace damaged section with a new section.
- Reprime the pump.
- Check the Smart-Skim or Auto Skim valve isn't jammed.
- Make sure the pool water level is high enough.
- Check the Smart-Skim or Auto Skim valve isn't sitting above the waterline. If it is, fit an anti-vortex washer on the valve.

VTX-3 is always coming to the surface of the pool, possibly drawing in air:

- Check that the Smart-Skim (see page 7) or Auto Skim valve (see page 12) is installed correctly.
- Check that there are no large leaves blocking the Smart-Skim valve and creating excess vacuum.
- Check the hose weights are fitted correctly and readjust if necessary.

How to unkink or uncoil your hose

Option 1

- The easiest method is to lay it flat by the pool for a few hours on a hot day (above 28°C).

Option 2

- If the weather is cooler, lay the hose out straight and fill it with warm (50-60°C) not boiling water. Roll the water backwards and forwards until the hose warms up and uncoils. Empty the warm water and then pour cold water through the hose – either manually or by attaching one end to the pump.

Option 3

- If option 1 or 2 is not possible simply rotate every 2nd length 180° to reduce the kinks.

TIP: When removing your hose from the pool break it down into 1m or 2m lengths and store flat. This will assist in stopping kinking and coiling, which impacts performance.

NOTE: For more detailed troubleshooting advice please don't hesitate to contact your helpful local dealer, or check our online resources for tips and other information: www.kreepykrauly.com.au

How to check the flow valve

- This will need to be periodically checked or conducted when there is a blockage.
 - Remove the sole and then seal
 - Remove the baffle plate by firmly pressing the plastic side tabs inwards or using a flat head screwdriver

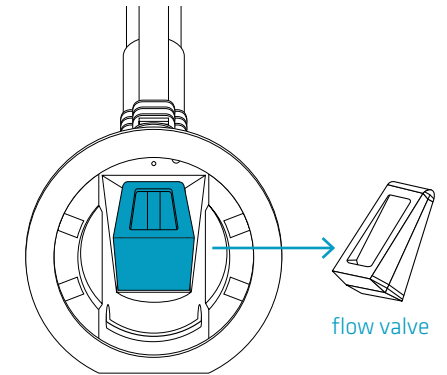
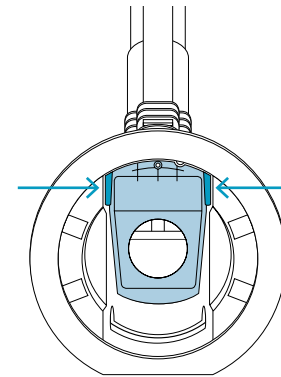

- Remove and clear debris from the flow valve
- Replace flow valve and baffle plate. Ensure prongs on baffle plate are not damaged or missing. Replace if required

- Refit the seal, slip rings and sole

Beware of the pool blanket effect

Pool blankets prevent chlorine evaporating. If you're using one, carefully monitor your chlorine or salt water setting to avoid over chlorinating your pool, which can harm your VTX-3 and void your warranty. If you have any questions please call our Customer Service department on 1800 777 255 or talk to your pool shop pro.

Looking after your VTX-3

- **IMPORTANT** If you are giving the water a shock treatment with chlorine or other chemicals, remove your VTX-3 from the pool for at least 24 hours. If the chemicals are too strong for people to swim in, they're too strong for the VTX-3.
- Do not use petrol or solvents to clean your VTX-3 as they will damage it. If needed, use detergent and water.
- Periodically check the suction seal, scrubbing sole and bumper for wear and tear. If they need replacing, see your pool shop.

TIPS TO PROTECT YOUR HOSE:

- Never stretch or lift the hose while it is full of water
- Never hang your hose from hooks
- Always store your hose loosely coiled (minimum 1m diameter) on a flat surface or, ideally, disassemble and store straight – particularly if storing long term. This will prevent the hose from kinking and ensure your VTX-3 can move freely when you return it to the pool.

What should I expect from my VTX-3?

How it moves

Your Kreepy Krauly VTX-3 will move backwards in direction, with the water flowing through the base of the cleaner and alternately diverted between the two drive tubes. The kinetic energy generated by the water being trapped in each drive tube provides the lifting and propelling motion of the cleaner, which may result in a faintly audible 'ticking' sound.

How it Steers

Your cleaner steers utilising its floatation assembly to create a Unique Crisscross Pattern. This allows your cleaner to efficiently cross the pool floor. In combination with the Ultra Flex hose, which ensures your cleaner is not restricted or directed by the hose.

How it Cleans

Your VTX-3 will clean your pool daily with your normal filter cycle by gently Skimming, Scrubbing and Vortex Vacuuming your pool surface. Its side scoop in combination with Smart-Skim will remove leaves and debris from the floor and water surface and direct them to your skimmer basket and filter. Don't be shocked if at first you see a white cloud appear around your cleaner, this is calcium build up being gently removed from your pool surface. The entire system efficiently delivers our promised Triple Clean with Vortex.

The Ultra Flex Hose

The unique Ultra Flex hose rests just below the water surface, due to its buoyancy and hose weights. The ultra flex design means when the cleaner crosses paths with the hose section closest to the cleaner, it is able to move freely. This gives your cleaner the freedom and mobility to clean your pool so you can relax and enjoy your pool.

Your Warranty

Your VTX-3 is engineered to last. This is reflected in the 2-year Full System Warranty and 10-year Flow Turbine Warranty.

Protecting Your Warranty

All Kreepy Krauly pool cleaning systems are made in Australia to withstand harsh Australian conditions. They are manufactured from top quality materials that are UV, salt and chemical resistant. Being an Australian company, we offer local after sales service, maintenance and parts. For any troubleshooting with your VTX-3, simply contact your local pool shop for assistance. You will extend the life of your VTX-3 by using genuine VTX-3 parts and chlorinating your pool correctly. Please note, we recommend removing the cleaner from the pool when shocking your pool. The use of non-genuine parts and over-chlorinating your pool may void your warranty, impair your VTX-3's performance or result in colour fade.

Activating Your VTX-3 Warranty

To activate your 2-year Full System Warranty and 10-year Flow Turbine Warranty, please fill in your VTX-3's serial number and return the self-addressed warranty registration card with your proof of purchase to us as soon as possible. Alternatively, you can activate your 2-year Full System Warranty and 10-year Flow Turbine Warranty online at www.kreepykrauly.com.au/warranty.

Record Serial Number Here:

TIP: Your Serial Number can be found on the packaging or at the bottom of your cleaner's main body.

NOTE: For full warranty conditions, please refer to your warranty card or go online to www.kreepykrauly.com.au/warranty

Further Information

This booklet should have answered all your questions. However if you need a little extra help or up-to-date information, go to **www.kreepykrauly.com.au**, or call our Customer Service Department on 1800 777 255, Monday to Friday 9am-5pm in your local area. Alternatively, contact your local pool shop professional.



www.kreepykrauly.com.au

We reserve the right to revise, change, or modify VTX-3 without incurring any obligations to make like changes on VTX-3 models previously sold. This publication remains the sole copyright of Sherwood Overseas Co Pty, Ltd