

# Robotic Pool Cleaner LIBERTY

# LIBERTY™ 200 | 300 | 400

## User Instructions



8159110



| maytronics™

EN

8159110-WEB

**LIBERTY 200 | 300 | 400**  
**Cordless Robotic Pool Cleaner**

User Instructions

**Contents**

- 1. Getting Started..... 3
  - 1.1 What's in the Box ..... 3
  - 1.2 First Time Use..... 3
- 2. Specifications..... 4
  - 2.1 Robot..... 4
  - 2.2 Water conditions ..... 4
- 3. Features and indications ..... 4
- 4. Charging recommendations ..... 5
- 5. Removing the robot from the pool..... 5
  - 5.1 Using the grab hook ..... 5
  - 5.2 Using the ClickUp™ clicker (Liberty 300 + 400)..... 5
  - 5.3 End of Cycle Pickup (Liberty 400)..... 5
- 6. Cleaning the filter basket..... 6
- 7. Periodic cleaning - recommended at least once a month ..... 7
- 8. MyDolphin™ Plus App User Guide..... 8
  - 8.1 Getting Started with the MyDolphin™ Plus App..... 8
  - 8.2 Prepare the Pool Cleaner for Connection ..... 8
  - 8.3 Activate the Pool Cleaner Using your Mobile Smart Device ..... 8
- 9. MyDolphin™ Plus Troubleshooting ..... 9
- 10. Robotic Pool Cleaner Troubleshooting ..... 9
- 11. Off Season Storage..... 10
- 12. Warnings and cautions ..... 11
  - 12.1 Warnings ..... 11
  - 12.2 Cautions..... 11

# LIBERTY 200 | 300 | 400

## Cordless Robotic Pool Cleaner

### User Instructions

## 1. GETTING STARTED

### 1.1 What's in the Box

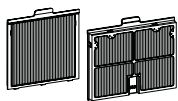
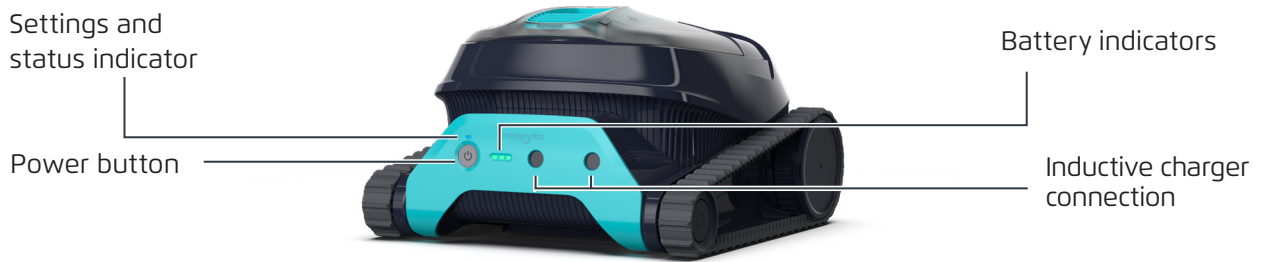

Extra filter panels\*

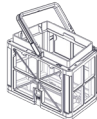

Filter basket



Grab hook

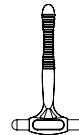

Clicker\*

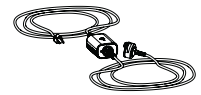

Charger

\* LIBERTY 300 & 400 only

### 1.2 First time use

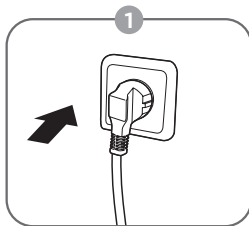

Plug the charger into the wall outlet

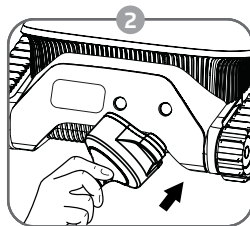

Connect the inductive charger to the robot



Peel-off the sticker

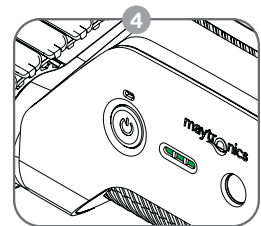

Charge the battery to 100% - 3 green bars

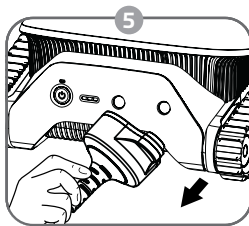

Unplug the inductive charger

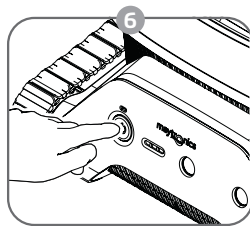

Press the power button

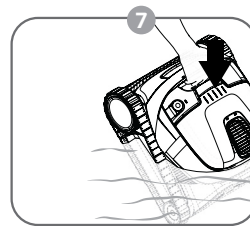

Put the robot in the pool. It will start cleaning within 30 seconds

## 2. SPECIFICATIONS

### 2.1 Robot

Water temperature range: 6°C - 35°C / 43°F - 95°F

Water depth range: 0.4m - 3m / 1.33ft - 9.8ft

Motor protection: IP 68

Charger protection: IP 54

Battery Lithium-ion | 5,000mAh | 25.2V ; 5Ah / 126Wh

Radio communication: Bluetooth® 5.0 - 2402-2480 MHz - Maximum power 2.1mW

### 2.2 Water Conditions

Use the robotic pool cleaner only in the following water conditions:

- Chlorine: 4 ppm max.
- pH: 7.0 – 7.8
- Temperature: 6°C – 35°C / 43°F – 95°F
- NaCl: 5000 ppm max.

## 3. FEATURES AND INDICATIONS



#### Cycle Selector - LIBERTY 300 & 400

Use Cycle Selector to customize cleaning mode to "Floor only":

1. Press ON to activate until the LED lights up.
2. Press ON again for 3-6 seconds until the purple LED blinks 3 times. Place the robot in the pool, and within 30 sec, it will start working. After each cleaning cycle, the robot will return to default mode.



Step 1



Step 2



#### ClickUp™ - LIBERTY 300 & 400

Easily take the robot out of the pool by shaking the Clicker in the water for 3 seconds when the robot has finished the cleaning cycle. The robot will climb up its nearest wall and wait a few seconds to be picked up.



#### Eco Mode - LIBERTY 300 & 400

Use Eco Mode to keep your pool floor clean for a week on one charge.

The robot will automatically clean the pool floor for up to 30 min, three times a week, with 48 hours between cleaning cycles.

1. Press ON to activate until LED lights up.
2. After 3 seconds, you will see a purple LED flashing. Hold the button until you see the green LED flashing.
3. Place the robot in the pool, and within 30 sec, it will start working.

While in Eco Mode you can use the Clicker between cycles and at the end of the third cycle, however using the clicker will cancel the eco mode.



Step 1



Step 2



#### Temperature Warning

In case of temperature warning notification, place and charge the pool cleaner in a protected and shaded area, at a temperature range of 6°C - 35°C / 43°F - 95°F.



#### Waterline Scrubbing - LIBERTY 400

Scrubs then removes grime and oils that accumulate on the waterline.



#### MyDolphin™ Plus Mobile App - LIBERTY 400

Download the app, sign-up and follow the app instructions to pair with your robot. You can configure it with the MyDolphin™ Plus App while the robot is out of the water. When paired, the LED above the robot's power button will start flashing. Now you can schedule cleanups, set cleaning cycle type, and receive notifications when it is ready to be taken out of the pool.



#### Error

In case of error notification, please refer to User Manual.



## 4. CHARGING RECOMMENDATIONS

- When the battery is low and all indicators are off - the cleaner is on standby mode. Connect the charger to the robot to wake it up.
- Always charge the pool cleaner in a protected and shaded area at a temperature range of 6°C - 35°C / 43°F - 95°F, until you see 3 green bars in the battery indicator panel (up to 6 hours).
- Make sure that the charger surface and power unit surfaces are clean, and there is no object between the robot and the charger.
- The charger is rainproof, the robot can be charged when wet. However, do not put the charger in the water. It is not designed to be underwater.

## 5. REMOVING THE ROBOT FROM THE POOL

### 5.1 Grab hook

Pull robot to waterline, then grab it.

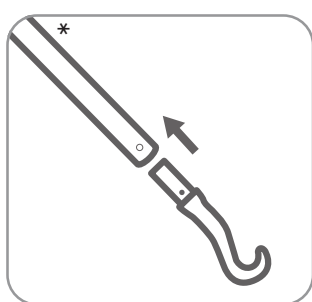

1



2

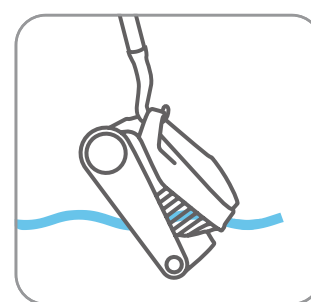

3

\* Standard pole, not included

### 5.2 ClickUp™ - LIBERTY 300 & 400

After the cleaning cycle, shake the Clicker inside the water for over 3 seconds and the robot will climb its nearest wall. The robot needs to finish its cycle before it can be called up with the Clicker.

In regular mode, the feature will be available for 6 days after the cleaning cycle ends.

Please note: When in Eco Mode, you can use the Clicker between cycles and at the end of the third cycle, however using the clicker will cancel the Eco Mode.

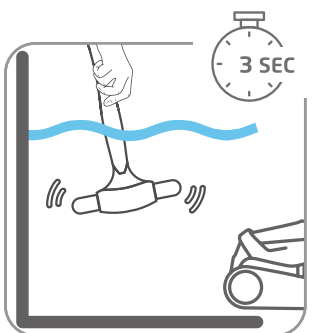

1



2

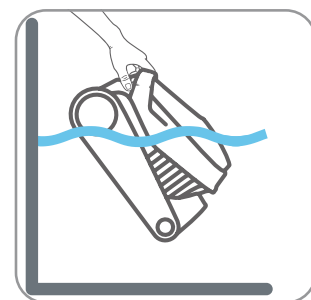

3

### 5.3 End of Cycle Pickup - LIBERTY 400

In the last few minutes of its cleaning cycle, it will climb each wall and wait 20 seconds to be taken out. If you started the cycle with the app, you will get a push notification on your phone to let you know the robot is waiting. If it isn't picked up, it will wait on the floor near a wall. You can then use the Clicker or hook to take it out.

## 6. CLEANING THE FILTER BASKET

To prevent debris from hardening on the filter, we highly recommend quick-rinsing the filter immediately after removing the robot from the pool.

### Rinsing after each use - removing and cleaning the filter basket

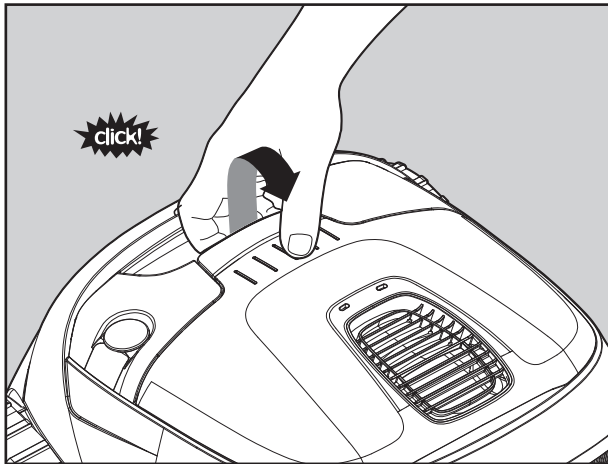

Open the filter cover.

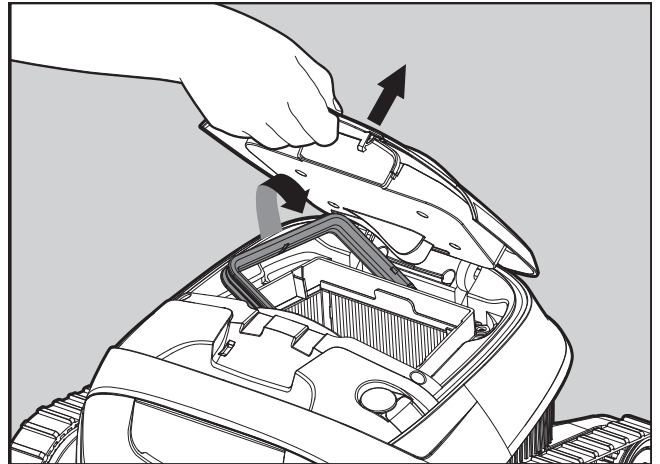

Upon opening the filter cover, the handle will lift independently.

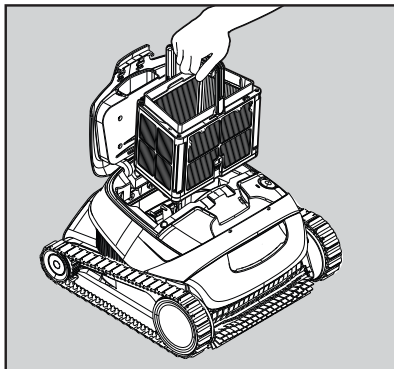

Lift up the basket.

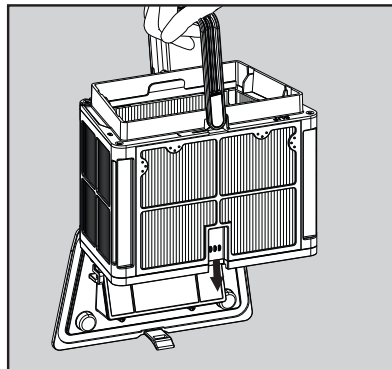

Open the latch to release the bottom lid in order to remove the debris.

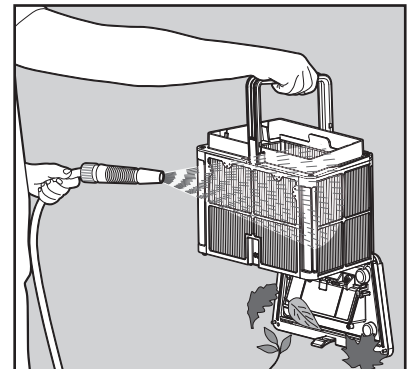

Rinse the filters from inside and outside with a hose.

## 7. PERIODIC CLEANING - RECOMMENDED AT LEAST ONCE A MONTH

Dismantle the 2 ultra-fine filter panels of the basket, using the following steps:

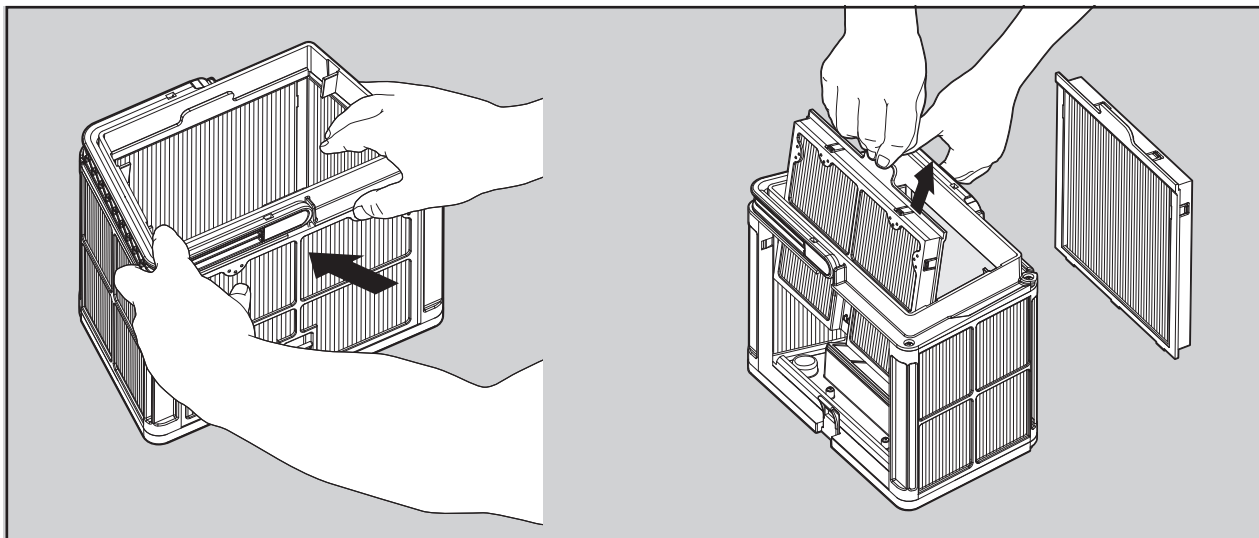

Dismantle the 2 panels with your thumbs.

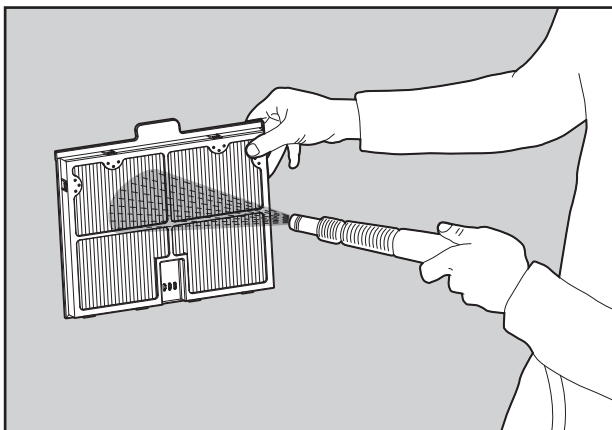

Clean the filter panels with a hose.

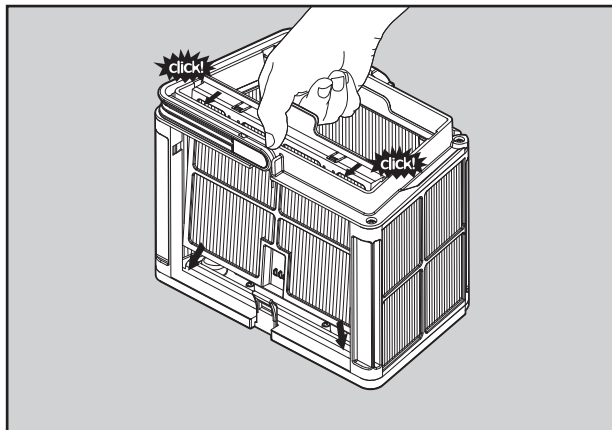

Re-assemble the filter panels.

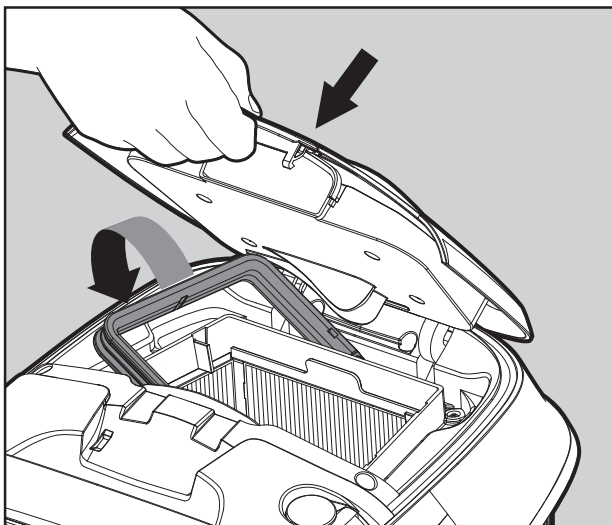

Insert the clean filter basket and close the filter cover.

## 8. MyDolphin™ Plus APP USER GUIDE

### 8.1 Getting Started with the MyDolphin™ Plus App

The app is compatible with the following smart devices:

- Apple (iOS) – version 10 and up – iPhone, iPad, iPod
  - Android – version 5 and up operating system
1. Ensure Bluetooth® is enabled on your smart device.
  2. Android users - please make sure your GPS and Location Services are ON.
  3. For iOS 13 only - while the app is working, enable Bluetooth® & location.

### 8.2 Prepare the Pool Cleaner for Connection

Connect the Pool Cleaner to the charger. This turns on the Bluetooth® for pairing.

### 8.3 Activate the Pool Cleaner Using your Mobile Smart Device

1. Activate the MyDolphin™ Plus app.
2. Click Agree and allow all the required permissions.
3. Sign up by creating an account or using your Gmail/Facebook accounts.
4. Select the "Cordless" power source. The app will search for your robot.
5. Alternatively, press "Search for your robot manually" to pair with your pool cleaner.  
When the app finds your robot, tap on the robot image to connect.
6. The app will start pairing with your robot. Please wait until the robot's LED blinks green and you receive a success message in the app.
7. Name your new Dolphin robotic cleaner and you're ready to go. If you start the cleaning cycle via the app, you will get a notification that your robot is at the end of its cleaning cycle.

**NOTE:** Next time you open the app, you will be prompted to fill in the warranty.

**TIP:** While pairing, if the app is stuck for over 2 minutes, close the app and retry pairing it.



## 9. MyDolphin™ Plus - TROUBLESHOOTING

Symptom	Possible reason	Corrective action
Cannot pair the smartphone app to the robotic pool cleaner.	<ul style="list-style-type: none"> <li>• The Bluetooth® on one of your devices is either off or not in pairing mode.</li> <li>• The phone is too far from the robot.</li> <li>• You did not give the required permissions when installing the app.</li> </ul>	<ul style="list-style-type: none"> <li>• Turn the Bluetooth® off and on in your smartphone. For iOS – Go to settings → Bluetooth®.</li> <li>• Get closer to the power supply.</li> <li>• Check that the robot's charger is connected well and that your phone's Bluetooth® is searching for nearby devices.</li> <li>• Try uninstalling and reinstalling the MyDolphin™ Plus app, and give all permissions. If it still doesn't find your robot, try restarting your phone.</li> <li>• If none of the above troubleshooting helps, contact Customer Care</li> </ul>
Robot is not waiting at the waterline when I arrived. It is standing near a wall.	It waits for a few seconds and then climbs another wall. After climbing 3 walls, it will wait by the wall to prevent running out of energy,	<ul style="list-style-type: none"> <li>• Shake the Clicker in the water for 3 seconds and it should climb up.</li> <li>• Connect the provided hook to your cleaning pole, and lift the pool cleaner to the waterline with the hook. At the water line pull the robot out.</li> </ul>

Issue	Suggested Action
Robot does not turn ON from the app.	<ul style="list-style-type: none"> <li>• Make sure that the robot is charged with all three LEDs green.</li> <li>• After turning it ON, place it in the water. It is designed not to work outside of the water.</li> </ul>

## 10. ROBOTIC POOL CLEANER - TROUBLESHOOTING

Symptom	Possible reason	Corrective action
The Robotic Pool Cleaner does NOT move.	<ul style="list-style-type: none"> <li>An object is stuck in the tracks or wheels.</li> <li>The robot is not charged</li> </ul>	<ul style="list-style-type: none"> <li>Carefully remove the object from tracks or wheels.</li> <li>Charge the battery to 100% -3 green bars</li> <li>Contact Customer Care</li> </ul>
The robotic pool cleaner is moving in circles.	<ul style="list-style-type: none"> <li>Clogged filter basket.</li> <li>Debris stuck in the impeller housing or impeller cover.</li> <li>The pool's surface is too glossy for this robot model.</li> <li>Algae buildup or pool water does not meet specifications.</li> </ul>	<ul style="list-style-type: none"> <li>Clean the filter basket.</li> <li>Contact Customer Care</li> </ul> <ul style="list-style-type: none"> <li>Correct pool and water conditions.</li> </ul>
The robotic pool cleaner does not turn or moves in one direction only.	<ul style="list-style-type: none"> <li>Debris stuck in the impeller housing or impeller cover.</li> </ul>	<ul style="list-style-type: none"> <li>Contact Customer Care</li> </ul>
The Robotic Pool Cleaner moves but does not clean the pool.	<ul style="list-style-type: none"> <li>Clogged filter basket.</li> <li>Debris stuck in the impeller housing or impeller cover.</li> </ul>	<ul style="list-style-type: none"> <li>Clean the filter basket.</li> <li>Contact Customer Care</li> </ul>
The robotic pool cleaner does not climb up the walls.	<ul style="list-style-type: none"> <li>The filter is too full to allow proper jet propulsion up the wall. Debris is stuck in the impeller housing.</li> <li>The pool surface is too slippery.</li> <li>Algae on walls.</li> <li>Unsuitable pH level.</li> </ul>	<ul style="list-style-type: none"> <li>Clean the filter and make sure that there is nothing stuck in the impeller.</li> </ul> <ul style="list-style-type: none"> <li>Check the level of chemicals in the water. Improper levels may allow the growth of algae, making the walls slippery. If so, adjust the levels and scrub the walls.</li> </ul> <ul style="list-style-type: none"> <li>Contact Customer Care</li> </ul>

## 11. OFF-SEASON STORAGE

Before off-season storage - we recommend charging the battery to about 50% (2 green bars in the battery indicator panel).

Recommended storage temperature range: -10°C - 40°C / 14°F - 104°F.

Storing the robot in a hot location will likely damage the battery.

After off-season storage, charge the robot to its fullest.

## 12. WARNINGS AND CAUTIONS

### 12.1 Warnings



- Remove the robotic pool cleaner from the pool before allowing people to enter the pool.
- When examining the robotic pool cleaner, make sure the robotic pool cleaner is switched OFF.
- Charge the battery only in the temperature range between 6°C to 35°C / 43°F to 95°F
- Keep the robotic pool cleaner out of the reach of children or persons with reduced physical, sensory, or mental capabilities, or lack of experience and knowledge, unless they have been given supervision or instruction. Cleaning and maintenance shall not be made by children.
- Use only the original battery charger.
- The battery charger must be supplied through a residual current device (RCD) having a rated residual operating current not exceeding 30mA.
- The power cord is not user-replaceable. If the power cord is damaged, stop using the battery charger and contact the service center for repair. Do not use extension cord to connect the battery charger to electric supply; provide a properly located outlet.
- DO NOT USE the robotic pool cleaner and/or its battery / power pack in case of mechanical damage to the robotic pool cleaner and/or its battery.
- To avoid the risk of fire and burns, DO NOT open, crush, heat, or burn the battery case.

### 12.2 Cautions



- Keep hands and fingers away from impeller motor area and driving belt mechanism to avoid injury.
- Position the battery charger at least 3.5 m / 12 ft from pool edge during operation.
- For continuous protection against possible electric shock, place the battery charger at least 11 cm / 4 in in above ground.
- When lifting the robotic pool cleaner, take care to prevent back injury.
- Do not use the robotic pool cleaner if you have added liquid flocculant or any other clarifier to the pool water. These substances obstruct and damage the robot's filters.
- The Lithium-Ion battery in this product is non-replaceable. It should be recycled at certified battery electronics recyclers that accept batteries. Batteries should NOT be discarded in the trash or put in municipal recycling bins. Do not disassemble the battery.

## Contact Maytronics Customer Care:

Australia, NZ, South Africa

 1 300 693 657

 [infoau@maytronics.com](mailto:infoau@maytronics.com)